



PREVIEW

# MK 6-10 System



SERIE STANDARD

**Höhe innen 203 und 243**  
Internal height 203 and 243

**Kühlzelle mit oder ohne Bodenpanel**  
Cold rooms with and without floor panels

**Tür mit Rechts- oder Linksanschlag**  
Door with right or left opening

**Vorbereitet für Integriertkühlmodule**  
Prepared to assemble freeblock or misasplit

**mit Druckausgleichsventil bei Tiefkühlzellen**  
Compensation valve applied on negative cold rooms

**18 Modelle mit einer Wandstärke von 6-10 cm und Volumen von 4 m<sup>3</sup> bis 16,7 m<sup>3</sup>**

The range is composed of 18 coldrooms with panel thickness 6-10 cm and volumes going from 4 to 16,7 cubic mts.

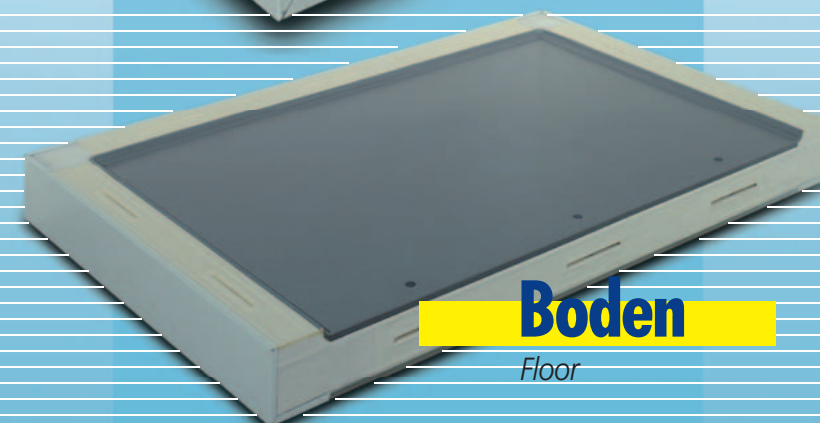
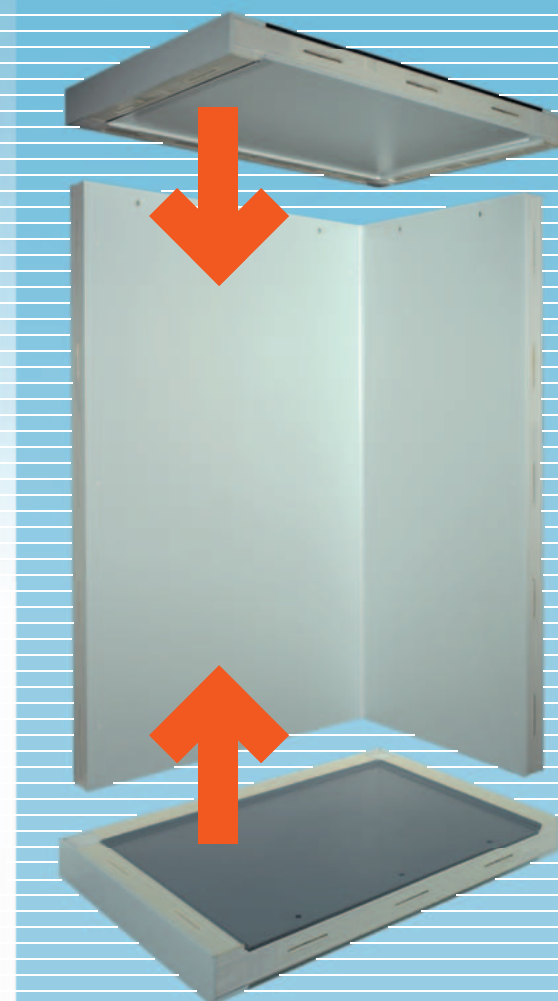

0 °C	hi 203			hi 243		
	MODELL	m <sup>3</sup>	FREEBLOCK FB	MISASPLIT MSG	m <sup>3</sup>	FREEBLOCK FB
MK6 12-16	4,1	FB 3T	MSG 7P	4,9	FB 7T	MSG 7P
MK6 12-20	5,1	FB 7T	MSG 7P	6,1	FB 7T	MSG 7P
MK6 12-24	6,1	FB 7T	MSG 7P	7,3	FB 13T	MSG 13P
MK6 16-16	5,4	FB 3T	MSG 7P	6,4	FB 7T	MSG 7P
MK6 16-20	6,7	FB 7T	MSG 13P	8,0	FB 13T	MSG 13P
MK6 16-24	8,0	FB 13T	MSG 13P	9,6	FB 13T	MSG 13P
MK6 16-28	7,1	FB 13T	MSG 13P	11,2	FB 16T	MSG 16P
MK6 20-16	6,7	FB 7T	MSG 13P	8,0	FB 13T	MSG 13P
MK6 20-20	8,4	FB 13T	MSG 13P	10,0	FB 13T	MSG 13P
MK6 20-24	10,0	FB 13T	MSG 13P	12,0	FB 16T	MSG 16P
MK6 20-28	11,7	FB 16T	MSG 16P	14,0	FB 16T	MSG 16P
MK6 24-16	8,0	FB 13T	MSG 13P	9,6	FB 13T	MSG 13P
MK6 24-20	10,0	FB 13T	MSG 13P	12,0	FB 16T	MSG 16P
MK6 24-24	12,0	FB 16T	MSG 16P	14,3	FB 16T	MSG 16P
MK6 24-28	14,0	FB 16T	MSG 18P	16,7	FB 20T	MSG 18P
MK6 28-16	9,4	FB 13T	MSG 13P	11,2	FB 16T	MSG 16P
MK6 28-20	11,7	FB 16T	MSG 16P	14,0	FB 16T	MSG 16P
MK6 28-24	14,0	FB 16T	MSG 18P	16,7	FB 20T	MSG 18P

-20 °C	hi 203			hi 243		
	MODELL	m <sup>3</sup>	FREEBLOCK FB	MISASPLIT MSG	m <sup>3</sup>	FREEBLOCK FB
MK10 12-16	4,1	FB 3N	MSG 6N	4,9	FB 6N	MSG 6N
MK10 12-20	5,1	FB 6N	MSG 6N	6,1	FB 13N	MSG 13N
MK10 12-24	6,1	FB 13N	MSG 13N	7,3	FB 13N	MSG 13N
MK10 16-16	5,4	FB 3N	MSG 6N	6,4	FB 13N	MSG 13N
MK10 16-20	6,7	FB 13N	MSG 13N	8,0	FB 13N	MSG 13N
MK10 16-24	8,0	FB 13N	MSG 13N	9,6	FB 13N	MSG 13N
MK10 16-28	7,1	FB 13N	MSG 13N	11,2	FB 13N	MSG 13N
MK10 20-16	6,7	FB 13N	MSG 13N	8,0	FB 13N	MSG 13N
MK10 20-20	8,4	FB 13N	MSG 13N	10,0	FB 13N	MSG 13N
MK10 20-24	10,0	FB 13N	MSG 13N	12,0	FB 20N	MSG 20N
MK10 20-28	11,7	FB 20N	MSG 20N	14,0	FB 20N	MSG 20N
MK10 24-16	8,0	FB 13N	MSG 13N	9,6	FB 13N	MSG 13N
MK10 24-20	10,0	FB 13N	MSG 13N	12,0	FB 20N	MSG 20N
MK10 24-24	12,0	FB 20N	MSG 20N	14,3	FB 20N	MSG 20N
MK10 24-28	14,0	FB 20N	MSG 20N	16,7	FB 20N	MSG 20N
MK10 28-16	9,4	FB 13N	MSG 13N	11,2	FB 13N	MSG 13N
MK10 28-20	11,7	FB 20N	MSG 20N	14,0	FB 20N	MSG 20N
MK10 28-24	14,0	FB 20N	MSG 20N	16,7	FB 20N	MSG 20N



PREVIEW

# MK 6-10 System

## MK Zubehör

ACCESSORIES

MK

## Isothermisches Panel

ISOTHERMICAL PANEL



Isothermisches Panel ummantelt mit nicht-toxischem vorlackiertem Stahlblech

ISOTHERMAL PANEL CLADDED WITH NON-TOXIC PREPAINTED STEEL SHEET

2 Höhe / 2 heights  
hi 203  
hi 243

# S10

# S6



MK

## Schneller Aufbau

QUICK ASSEMBLY

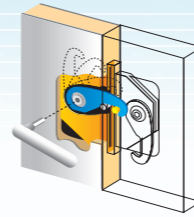
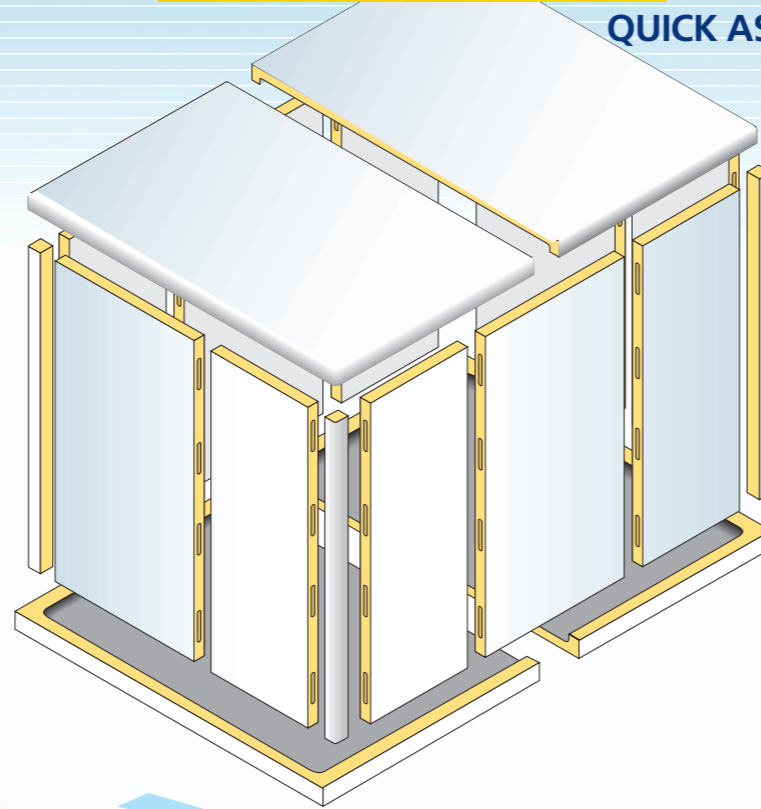

mit "Excenter"-Hakenverschlüssen

FASTENER - FASTFIT SYSTEM

Freeblock

Anschlußfertige Kühleinheit 40x80  
READY TO ASSEMBLE REFRIGERATING UNIT ON A 40x80 PANEL



## Misasplit MSG

Anschlußfertige - Verdampfeinheit 40x80  
READY TO ASSEMBLE EVAPORATOR UNIT ON A 40x80 PANEL



MK

## Neue Kanten R7

R7 NEW EDGE

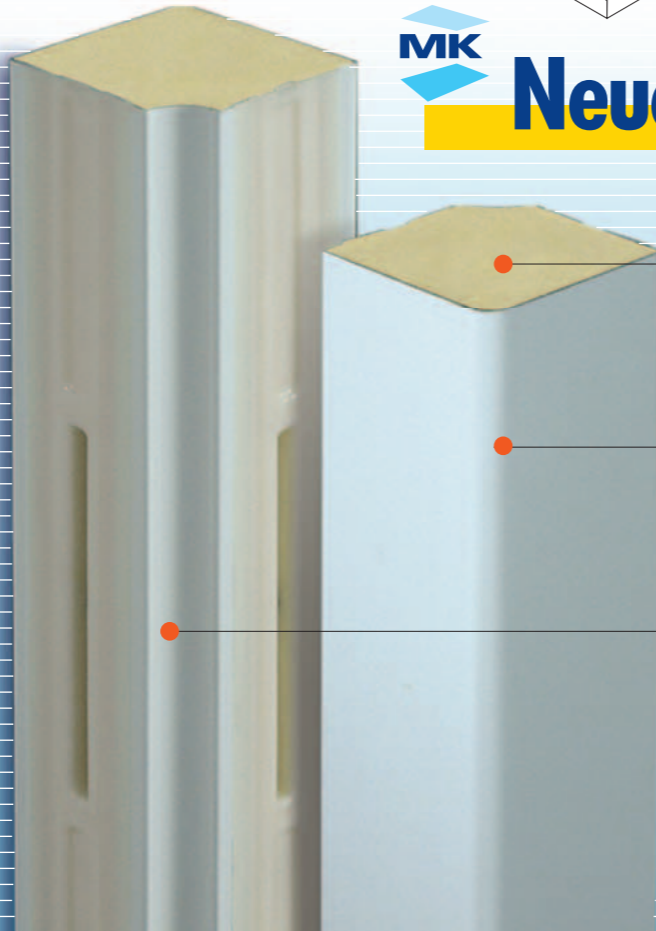

Polyurethan Isolierung

POLYURETHANE FOAM INSULATION

Außen abgerundeter plastifizierter Stahl Radius 7

EXTERNAL ROUNDED PLASTIFIED STEEL - RADIUS 7

Innen abgerundeter plastifizierter Stahl

INTERNAL ROUNDED PLASTIFIED STEEL

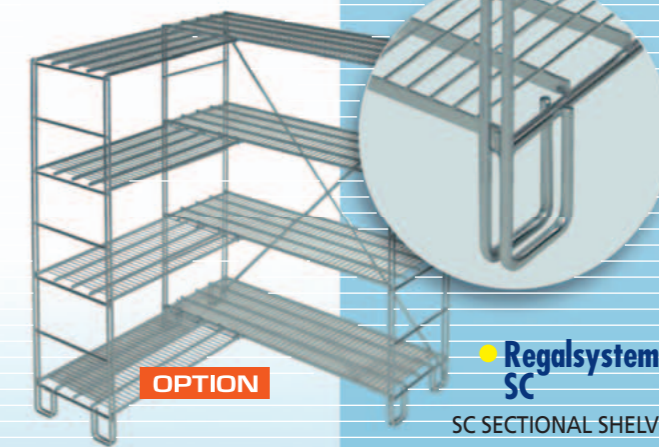

OPTION

Regalsystem SC  
SC SECTIONAL SHELVES



geteilter Vorhang  
STRIP CURTAIN



Aluminium Regale AL2  
ALUMINIUM SHELVES AL2

Haken  
HOOK HOLDERS

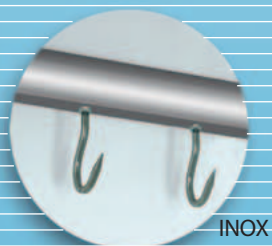

INOX C80

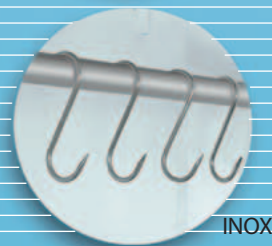

INOX C15